



PLANNING GUIDE

# Walkways and Driveways on Roofs and Decks

Life on Roofs



# Important Standards and Guidelines

This planning guide is an English translation of the German original version. Therefore particularly German and European standards and directives are listed, as far as existent. The walkway and driveway build-ups presented in the following have proven their reliability under the intended loads over many years. If specific standards and directives for the planning and the installation of walkways and driveways are valid in your country of course these are to be observed as well.

Guidelines for the Planning, Construction and Maintenance of Green Roofing – Green Roofing Guideline (The Landscape Development and Landscaping Research Society e. V. (FLL))

Recommendations for the Planning and Construction of Traffic Areas on Buildings (The Landscape Development and Landscaping Research Society e. V. (FLL))

Eurocode 1 (EN 1991) Actions on structures

- Part 1-1: Densities, self-weight, imposed loads for buildings (EN 1991-1-1)
- Part 2: Traffic loads on bridges (EN 1991-2)

Eurocode 2 (EN 1992) Design of concrete structures

- Part 1-1: General rules, and rules for buildings (EN 1992-1-1)

Waterproofing of buildings - German Standard DIN 18195

Regulations for Roofs with Waterproofing – Flat Roof Guideline (Organization of German Roofer Society ZVDH)

A number of guidelines, technical bulletins and additional technical contract terms of the German Road and Transportation Research Association (FGSV)

Not all standards and regulations are relevant for each project. Please consider also all relevant local and national regulations. The ZinCo Technical Department will assist you with project specific solutions.







# More Possibilities with ZinCo



General Information about Walkways on  
Roofs and Underground Garages 4



Walkways and Terraces on  
ZinCo Elefeet® Pedestals 6



Basics for Walkways on Roofs and  
Underground Garages 10



Walkways and Green Roofs with  
Floradrain® FD 40-E 12

Walkways and Used Areas on Drainage Elements 14



General Information about Driveways on Roofs 16

Driveways for Cars with Stabilodrain® SD 30  
and Fixodrive® FX 50 18

Driveways for Cars with Elastodrain® EL 202 20



Driveways for Lorries with Elastodrain® EL 202 22

Driveways and Green Roofs on Underground  
Garages with Protectodrain® PD 250 24



Special System Build-ups / Driveable Green Areas 26



System Build-ups for Walk- and Driveways with  
Floradrain® FD 60 neo 28

Reference Projects 30





# General Information about Walkways on Roofs and Underground Garages

At a progressing rate, roofs are being used holistically and now almost everything which can be realised on ground, is possible on roofs as well.

To create long lasting and functioning walkways and driveways on roofs it is crucial to use the right technique. This planning guide will provide essential information.

Additionally to the self weight and imposed loads on walkways and driveways, horizontal forces and torsional movements may occur through acceleration, steering or breaking.

Types of loads, weights and frequencies of use are described in EN 1991-1-1 and EN 1991-2 (see table on the right).

Symbol	Force	Load	Additional Forces
	Category H Single person, maintenance and servicing on green roofs, e.g. roof gardener, chimney sweeper	total load 1.0 kN/m <sup>2</sup> (at a critical point)	
	Category Z Residential Buildings	total load 4.0 kN/m <sup>2</sup> single load 2.0 kN/m <sup>2</sup>	
	Category F Light Vehicles up to 3t	total load 2.5 kN/m <sup>2</sup> single load 20 kN	Horizontal forces from accelerating, breaking, steering
	Category G Lorries with 3t to 16t	total load 5.0 kN/m <sup>2</sup> single load 90 kN	Horizontal forces from accelerating, breaking, steering
	Heavy duty vehicle with weights ≥ 16t	total load 16.7 kN/m <sup>2</sup> single load 170 kN (calculation according to EN 1991-2 possible as well)	Horizontal forces from accelerating, breaking, steering

EN 1991-1-1

## Drainage

In contrast to the run-off delay or retention of stormwater that occurs on green roofs water must be discharged almost completely from walkway and driveway areas on and below the surface.

The water run-off coefficient for paved surfaces varies from  $C = 0.8$  to  $1.0$ ; drains must be planned so that they allow for drainage on two levels: from the drainage level and from the surface area.

The ZinCo Product List offers the necessary system build-ups and accessories.

## Materials

Materials for base layers are defined in contract terms of the FGSV (German Road and Transportation Research Association). The FGSV supplies information about bedding courses and jointing material within their directives, terms of delivery and technical bulletins. For a gravel base layer a grain size of 0/45 is recommended. Grain size and grain size distribution ensure excellent compactability and stability.

Bedding material can come in different grain sizes, but has to harmonize with the jointing material to prevent it from being washed out. Essentially, crushed stone

finer-sand mixtures have a grain size of 0/2 or 0/4 and crushed stone finer-chippings mixtures have a grain size of 0/5. For water permeable surfaces grain sizes of 1/3 or 2/5 are recommended.

The ZinCo Technical Department is happy to help design the appropriate customised build-up.







## Inclination

What inclination is essential on walkways and driveways? What fall is needed for a roof? What fall shall be used for the waterproofing and what fall for the surfacing?

The "Flat Roof Guideline" as well as the German Standard DIN 18531 require a minimum fall of 2 % as standard; but also define how roofs with less than 2 % can be constructed. On roofs with less than a 2 % fall, the quality of waterproofing is even more important.

The inclination of the surface layer depends primarily on the surface material. Raised paving and decking do not need any slope since water can drain through the joints. Nonetheless, we recommend installing the flooring at a slight slope to prevent ponding, in particular in the case of large slabs.

Surfaces made of concrete or asphalt require a minimum inclination of 1.5 % and paver surfaces need a minimum of 2%. Establishing a slope is not a problem, if the waterproofing and the surface have

the same slope. If a slope different from the slope of the waterproofing has to be integrated into the surface, a gravel base layer is necessary. The slope cannot be created with the bedding layer, as it will result in uneven settlement.

In general, when designing a fall the connection heights need to be taken into consideration. If possible, surfaces should not allow water to drain towards the building structure. Therefore, these considerations should be incorporated early in the planning stage.

# Walkways and Terraces on ZinCo Elefeet® Pedestals

Some roofs do not have the load-bearing capacity to carry the load of the base layer, bedding material and surface layer. In this instance the ZinCo Elefeet® are able to bear the load, and as a result of its minimal weight, only the weight of the surface has to be taken into consideration.

Due to the high stability and load-bearing capacity of the pedestals, no chippings are needed as conventional laying material eliminating the need for sometimes costly transport and distribution of the material on the base area.

Thanks to the versatile and flexible range of accessories, it is possible to react to almost any constructional requirement and lay any desired type of decking and paving.



*Elefeet® E 27  
adjustable from  
27–39 mm*



*Elefeet® E 38  
adjustable from  
38–60 mm*



*Elefeet® E 60  
adjustable from  
60–106 mm*



*Elefeet® E 106  
adjustable from  
106–196 mm*



*Extension Pieces Elefeet® A 12,  
A 22 and A 67, for continuous  
extension and multiple combina-  
tions up to an installation height  
of approx. 500 mm.*



In this project it was decided to use Elefeet® to create a water reservoir underneath the surface layer in case of heavy rainfall.

Each Elefeet® is vertically adjustable by turning the swivel. Even after installation, a single slab can be lifted to adjust the relevant Elefeet®.

The new Elefeet® base plate allows the pedestal to be placed right up to the roof edge and, after a cut along the marked line, even directly into the corners.

## Accessories:



The protection of the waterproofing is ensured by the Protection Mat Elastosave ES 30 (1), which was specially designed for the use under Elefeet®.



The Cantilever Arm Support (2) allows for close connection to doors or insulating fillets. The doorstep height can be reduced to a minimum of 50 mm, if a grill (3) is used in front.

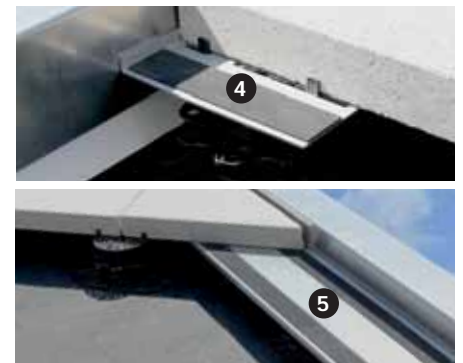

The practical edge holder (4) ensures a stable support in the edge areas. If the laying is not at right angles to the laying direction of the boards, the mitre and edge support (5) is used for this area.





from approx. 70 mm  
to approx. 500 mm

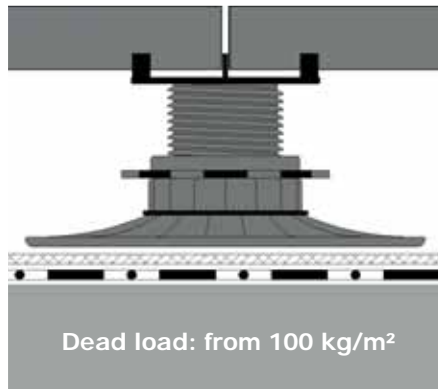

Slabs of e.g. concrete or natural stone, or ceramic or wooden decking\*

ZinCo Elefeet® (in various heights)

Elastosave ES 30, separation layer if required e.g. Slip Sheet TGF 20

Roof construction with waterproofing

\*Material thickness usually concrete > 40 mm, ceramic tiles > 20 mm, if approved by the manufacturer, less thickness is sometimes possible.

#### Installation of Elefeet® offers a number of important advantages:

- Precise levelling with vertical adjustment swivel including reverse rotation protection
- Very low weight – only the surface layer needs to be considered
- Simple to install due to easy-to-handle materials and high flexibility
- No transport problems (gravel, mortar) to and at the installation site
- Spring-loaded detent nose warns against unscrewing too far
- Open joints, free from pollution and weeds
- Firm support for cut-to-size slabs in the edge area
- Load bearing capacity up to 600 kg/pc
- Safe drainage of paving/decking and roof.
- Usable on roofs without any slope due to large drainage cavity.
- Excellent aeration of paving and decking.
- Hollow space usable for the installation of all types of cables.

#### The „quick“ alternative: Elastoring

If there is the requirement for a drainage profile while only a low build-up height exists, Elastorings are recommended. They are available in heights of 5, 10, 15 and 20 mm. The 1 mm thick levelling pad, which can also be folded and cut, is used to compensate unevenness.

There are special requirements of the substructure for the installation of the Elastoring: any slope showing up in the surface layer is caused by a sloped substructure and it is difficult to equalize; therefore, the substructure must be levelled. Also, the substructure must have a sufficient load bearing capacity.



# Prepared for everything with stability - The ZinCo Elefeet® Support Rail System



The quick-fix rail support clip allows the rail to be easily clipped into the head plate of the Elefeet® Pedestals.

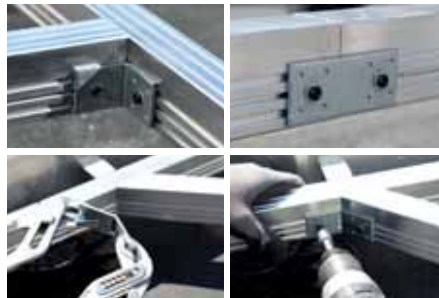

Due to the flexible rail connectors, it is possible to respond to almost any constructional challenge and necessary geometry of the substructure.



Steps, height offsets and other obstacles can be easily created or bypassed by combining Elefeet® Pedestals and the Elefeet® Support Rail System.

## Maximum flexibility using the Elefeet® Support Rail System:

- Less pedestals are required to achieve the same load bearing capacity
- Simple and faster alignment (pedestals at beginning and end are positioned first, intermediate pedestals only later)
- By interconnecting all elements the substructure ensures stability during installation and operation
- Substructure can be used several times (e.g. if the wooden deck needs to be replaced).
- Ideal substructure for thin-layer ceramic tile decks



- Light and weather-resistant substructure for wooden decks
- Laying the actual paving slabs and decks is much faster



The two edge holders ensure stability right up to the edge. These are available in two designs, one to be screwed to the side of the rail the other to be fixed at the head end of the rail.



The variable distance holder adapts to any desired surface format and provides a stable substructure with constant dimensions.

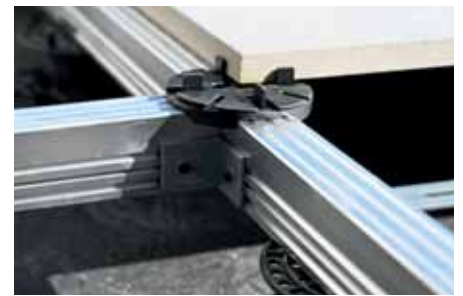

Tightly screwed to the rail system, the support plate with integrated joint spacer ensures that the laid pavers or tiles are kept from sliding.





For more detailed information on this build-up system please refer to our planning guide “Elefeet® System Solutions for Raised Paving and Decking” which can be downloaded at [www.zinco-greenroof.com/downloads](http://www.zinco-greenroof.com/downloads).

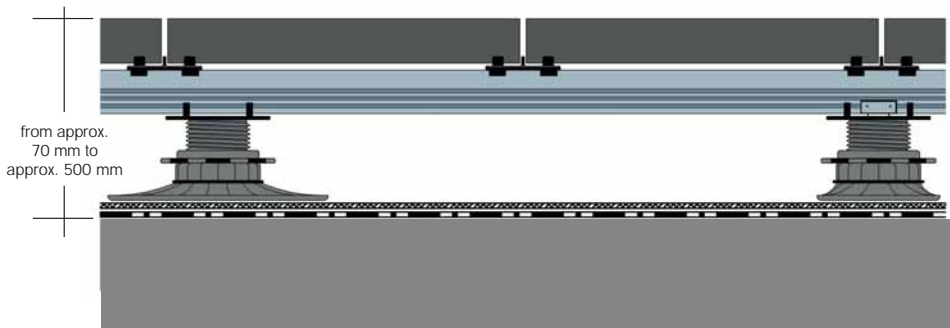

Slabs of e.g. concrete or natural stone, or ceramic or wooden decking\*

Elefeet® Support Rail with Support Plate

ZinCo Elefeet® (available in various heights) with fixing clip

Elastosave ES 30, separation layer if required e.g. Slip Sheet TGF 20

Roof construction with waterproofing

\*Material thickness usually concrete > 40 mm, ceramic tiles > 20 mm, if approved by the manufacturer, less thickness is sometimes possible.

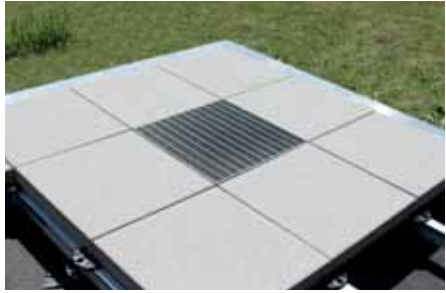

Elefeet® can be used for different surfaces such as the combination of concrete slabs and terrace grills.



Another variation is the application of a wooden surface. The desired slope can be created with the Elefeet® Pedestals.



This surface rises from the threshold towards the perimeter to get sufficient space for a green roof application.

# Basics for Walkways on Roofs and Underground Garages



Flat roofs – especially if they are sufficiently stable and easily accessible – are perfectly suitable for implementing walkways and sitting areas or even playgrounds and sports facilities. The risk of falls from a height can be prevented by means of balustrades, guardrails or a combination of the two.

When planning walkways on roofs, the weight of the build-up as well as the build-up height required have to be considered from the very beginning. In addition, the pressure resistance of the thermal insulation has to be sufficient for the walkway build-up.

During the installation of the different layers the waterproofing has to be

protected from damage. So, first of all an appropriate protection layer must be installed. This can be a protection mat, but it is also possible to install a drainage layer which functions as a protection layer as well, such as Elastodrain® EL 202 or Protectodrain® PD 250.

For the installation and compaction of a gravel base layer it has to be considered, that built structures can be susceptible to vibration. The drainage of hard landscapes mostly takes place on the surface. Therefore a sufficient slope towards the roof drains has to be allowed for. Above the drains removable terrace grills ensure that the water gets downwards and also keep the drains accessible for maintenance.



During the construction phase flat roofs are often used as storage space or place of constructions machines such as on the roof of the Reichstag in Berlin.



The combined protection and drainage layer, which has been applied here still protects the waterproofing membrane under the large scale concrete slabs.



The base for creative surface designs: Protectodrain® PD 250 makes almost everything possible.





Height  
mm

+

from 40

+

approx. 40

+

30

+

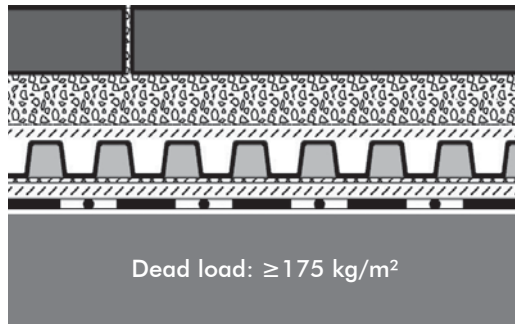

Concrete or natural stone  
slabs  $\geq 40$  mm or pavers  $\geq 80$  mm  
Bedding layer 30–50 mm  
Filter Sheet TG  
Protectodrain® PD 250  
Separation layer e.g. Slip Sheet TGF 20  
Roof construction with suitable  
waterproofing



After the Filter Sheet TG is rolled out  
over the drainage layer, the bedding  
layer ist levelled to provide adequate  
stability to the overlaying slabs.

# The Combination of Walkways and Green Roofs with Floradrain® FD 40-E



If the combination of walkways and green roofs is required, not only drainage and compressive strength are important, but also the water retention capacity. Floradrain® FD 40-E as the core piece of the build-up meets all requirements and ensures durable functionality. Depending on the installation it allows for water retention (diffusion holes facing up) or drainage of water (diffusion holes facing down).

Particular attention must be paid to the planning and construction of the transition between walkways and green landscape. If Floradrain® FD 40-E is

installed on the entire area on the protection mat, edgings or foundations can be concreted directly on top of the Floradrain® FD 40-E without hindering the water to drain.

Complex constructions with high installation or assembly costs do not apply since the incurred water flow can be drained, unhindered, along the underside of the drainage elements. Another benefit: There is only one kind of drainage element on the roof, which significantly reduces sources of error during installation.



At first sight a visitor would not realize he is on top of a roof.



Especially inner courtyards, which are visible from surrounding offices, offer the possibility to combine functionality and nature.



Green islands are visually pleasing and also bring life to roofs.



The possibility to include foundations in the build-up, allows the planner to design without limits.



The design of thresholds is flexible as long as they correspond to the "Flat Roof Guidelines" or any relevant national regulations.

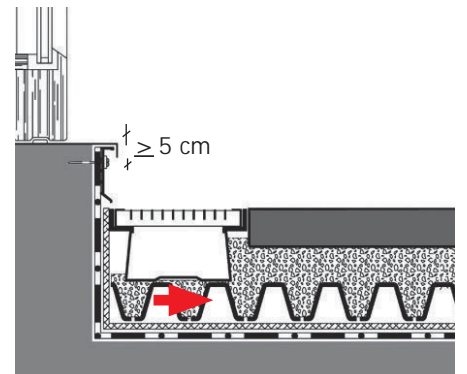

This well proven solution with the Façade and Terrace Channel meets the Guidelines as a "special solution".





from  
approx.  
12 cm

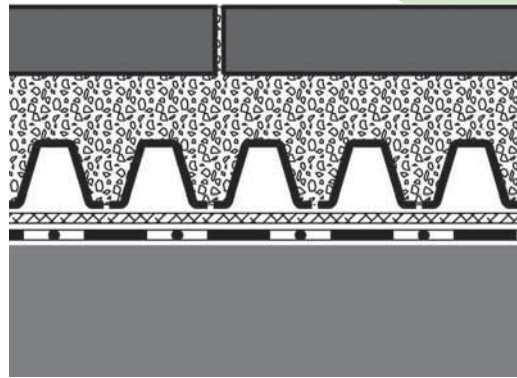

Concrete or natural stone  
slabs  $\geq 40$  mm or pavers  $\geq 80$  mm

Bedding layer 30–50 mm

Floradrain® FD 40-E infilled  
Protection Mat SSM 45

Roof construction with root  
resistant waterproofing

\* Cobble stones only to be installed in  
mortar.

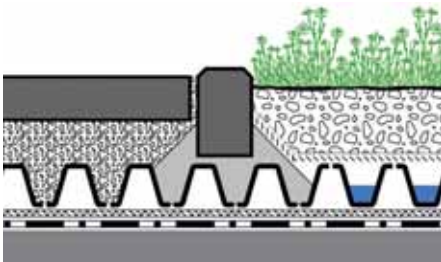

The drainage element used as formwork  
for a foundation ensures continuous  
drainage.



The continuous drainage layer allows for  
flexible designs and forms to be created  
in the subsequent layers.



Roof terrace shortly after completion:  
green areas partly raised above and  
partly levelled with walkways.



# Hard Landscapes for Pedestrian Traffic on Drained Surfaces: Build-up Alternatives and Details

Almost all ZinCo drainage elements are designed to ensure adequate compressive strength for pedestrian traffic. Various system build-ups can be used to design walkways on roofs and meet different

requirements, such as: an especially low build-up height (1); a higher water retention capacity of the build-up for the combination with intensive vegetation and dam up irrigation (2) or walkways

on inverted roofs (3). ZinCo can offer an appropriate system build-up for each of these requirements.

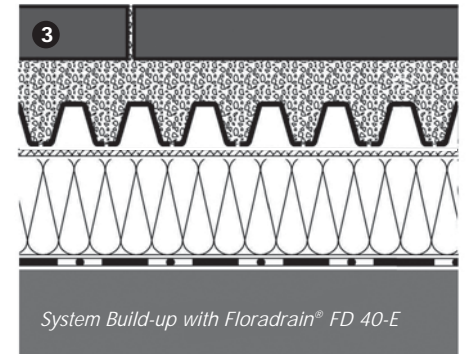
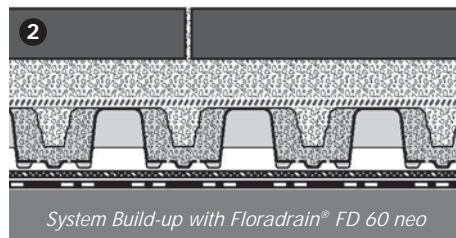
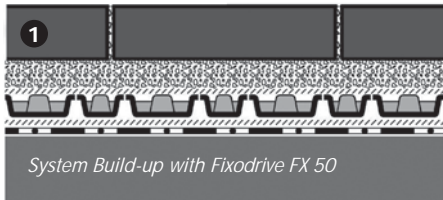

## Drainage

Discharge of the surface water on sealed surfaces is just as important as safe drainage below the surface. ZinCo drainage channels allow the water to be drained off on two different layers, the surface layer and drainage layer. They also allow easy access for cleaning and maintenance.

In front of a facade, implementing a drainage channel is a good alternative to pebbles; it allows water to drain quickly, reduces water backslash, and prevents plant growth. ZinCo grills and channels are vertically adjustable and can be used for diverse surface layers.

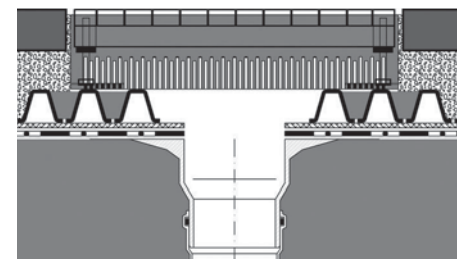





### Sporting surfaces

It is also possible to install special sport surfaces on ZinCo drainage elements (see example on page 30). The base layer and the drainage level underneath are able to drain the porous plastic surfaces. The ZinCo Technical Department is able to provide project specific solutions.



Elastic layer (permeable)  
 Drain asphalt  
 Gravel base layer  
 Filter Sheet PV  
 Floradrain® FD 40-E, infilled with chippings  
 Protection Mat ISM 50  
 Roof construction with suitable waterproofing



### Edging and borders

A stable edging is almost as important as a durable drainage element. ZinCo stainless steel profiles and concrete kerbs both present visually pleasing detail solutions. Placing the elements on top of the drainage layer does not impair water drainage.



# General Information about Driveways on Roofs: Torsional Moments Are Added to Compressive Stress...

## Loads

Driveways on roofs require both a load-bearing system build-up and a load-bearing roof construction.

If the static does not allow high loads, many trafficable roof surfaces are provided for load restriction, e.g. max. permissible axle load or trucks up to 3.5 tons.

Wheel loads have a narrow contact area, which leads to high point loads. It is crucial to plan sufficient load distribution either with load distributing surfaces or with an adequate base layer.

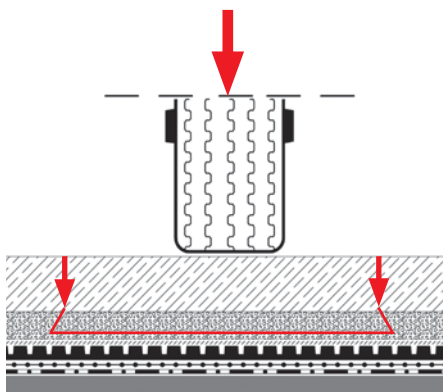

**Load bearing concrete surface**  
➔ load distribution across the entire slab

**Bedding**  
➔ additional load distribution of 60°

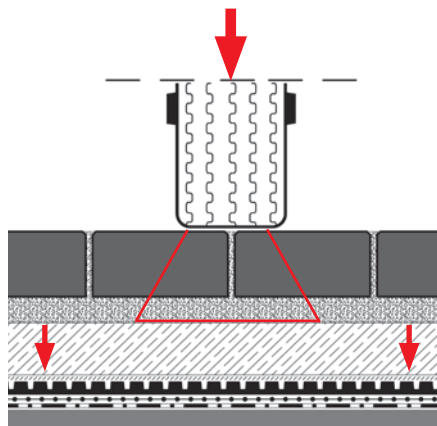

**Bedding and paving**  
➔ load distribution 60°

**Concrete base layer**  
➔ load distribution across the entire slab

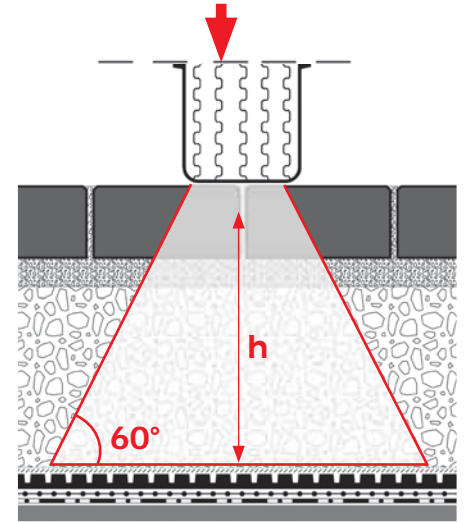

**Gravel base layer**  
➔ load distribution 60°

## Edging

The exceptional horizontal forces and torsional moments from steering, braking and accelerating must be absorbed. Special arrangements in addition, such as slip sheets, are necessary to prevent the waterproofing from being damaged. The forces also have to be absorbed at the edging. Support of the edges from the back is required to keep the surface layer and the bedding material in place. If walls provide the edging of the paving it is important to ensure a mechanical protection of the waterproofing membrane, e.g. with stable metal profiles.

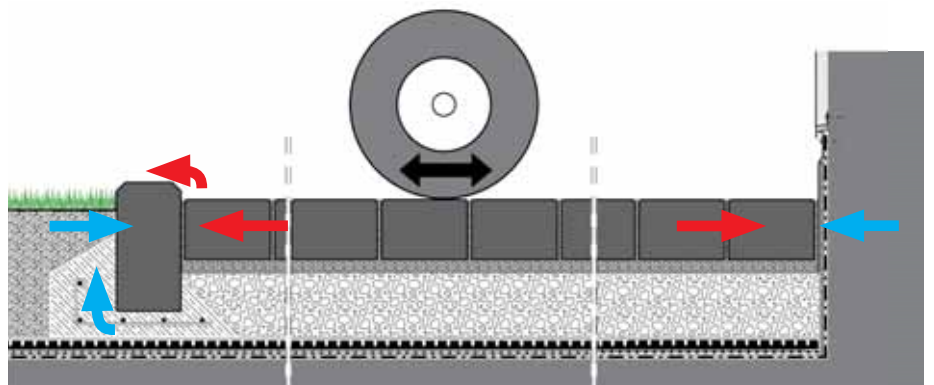





## Pavement

Paver and slab sizes are determined according to the loads to be expected. Surfaces with low loads, for example walkways, have fewer requirements than surfaces with high loads. On driveways for cars and lorries additional forces such as torsional moments etc. occur, and the thickness of the concrete slabs has to be properly calculated. A greater slab depth results in a greater support surface and in a reduction of a possible distortion.

Thin pavers and concrete slabs result in larger compressive forces on the supporting medium below. With loose bedding material, these forces are absorbed vertically and result in deformation.

Thicker paver material absorbs the horizontal forces over a broader area eliminating the deformation in the bedding material below.

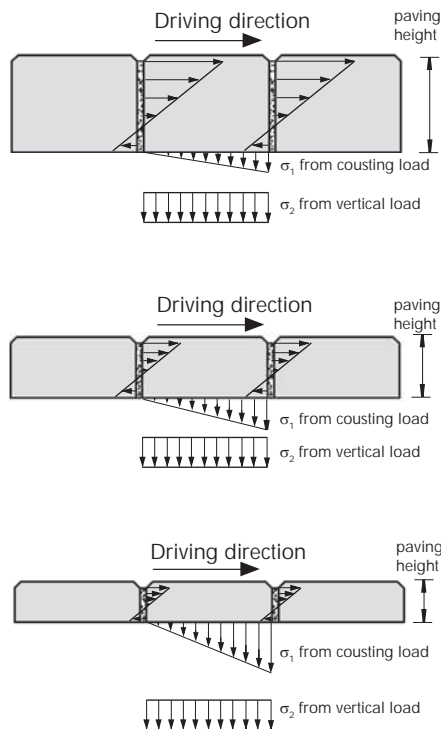

The arrows in the charts show the various forces. Thicker slabs absorb forces horizontally while thinner slabs absorb more vertically, due to a smaller supporting area at the sides. Therefore, deformation of the bedding layer will result with the thinner paver.

## Installation pattern

The installation pattern primarily depends on the architect's or owner's requirements. But not every design will be able to carry the appearing loads. The interlocking installation of pavement reduces deformation of the surface and extends its longevity. Another alternative is the diagonal installation of the pavement which has a greater absorption surface for horizontal forces. (All 4 sides of a slab serve as load distribution.) Generally, big slabs placed with cross joints are not recommended for driveways, because of their low load distribution ability.



# Driveways for Cars: System Build-ups with Stabilodrain® SD 30 or Fixodrive® FX 50



## 0°-slope

When building driveways on roofs of little or 0° inclination, puddles will form after rainfall and a special drainage layer is required.

Especially for installation under driveways the Stabilodrain® SD 30 drainage layer was developed. It is able to withstand heavy loads while maintaining efficient drainage in the 30 mm high cavity below.



With a drainage layer like Stabilodrain® SD 30 in place, conducting the excess facade water into the grills is no problem.



The edging, when concreted to the drainage element, provides a stable bordering.



If the entire roof surface is to be utilised, then an appropriate fall protection, such as a railing, is required.

## Sloped roofs

If the support structure has a sufficient slope, the use of Fixodrive® FX 50 is an economic alternative. It will be delivered to site with the pre-attached filter sheet and is therefore efficient to install. The connection by interlocking studs creates a large protection layer for the waterproofing.

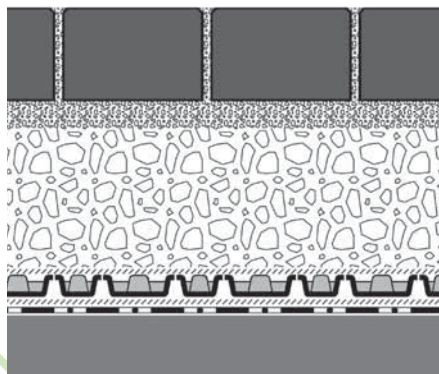
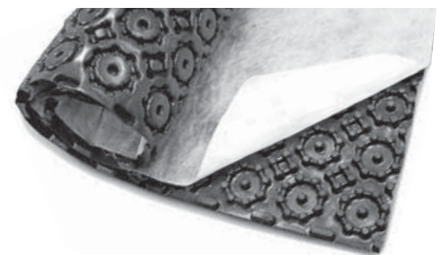

Pavers in bedding layer

Gravel base layer ≥ 150 mm

Fixodrive® FX 50

Filter Sheet PV

Roof construction with suitable waterproofing



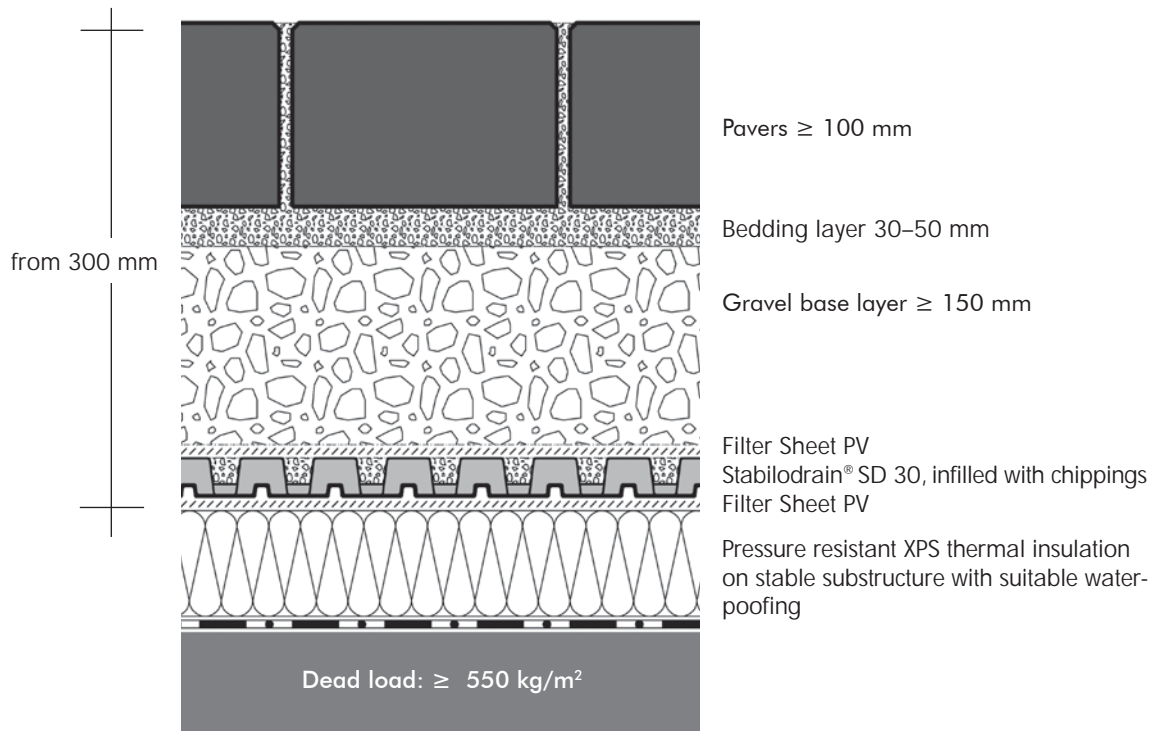

### Driveways on inverted roofs

When working on inverted roofs, it is essential to avoid creating any sort of vapour barrier above it. With Stabilodrain® SD 30 this is possible. As a first layer, the Filter Sheet PV is installed on top of the XPS thermal insulation. The Filter Sheet PV is extremely stable and allows for air and vapour passage.

The 1 m x 2 m Stabilodrain® SD 30 elements are filled with chippings and covered with the Filter Sheet PV; this is to prevent small particles of the gravel base layer from being washed out. The surface of the gravel base layer runs parallel to the slope of the driveway surface. On top of this surface the pavement can be installed into a bedding layer.



# Driveway for Cars – at Low Build-up Height with Elastodrain® EL 202

Vehicular traffic on a roof deck introduces very significant forces and stresses. As a result a very durable protection layer is crucial. This ZinCo System Build-up for cars employs the extremely stable Elastodrain® EL 202 specifically designed for these applications. The large number of studs results in a very high compressive

strength. The studs distribute the load evenly on the substructure. This system is designed for heavy loads. A prerequisite is the early planning for the slope of the driveway surface. The desired slope should ideally be designed into the roof construction. It is not permissible to create the slope within the

bedding material for the pavers. If the roof slope is not the same for the waterproofing and the pavement surface then an additional gravel base layer is necessary for creating the desired surface slope. In addition, the pavement thickness and orientation need to be suited to the application.

The Elastodrain® EL 202 is placed over the Slip sheet TGF 20. To connect the single elements (1 m x 1 m) connectors are used. The waterproofing is protected right after the installation of the EL 202. The gravel base layer can be installed by carefully driving wheel loaders over the drainage layer.

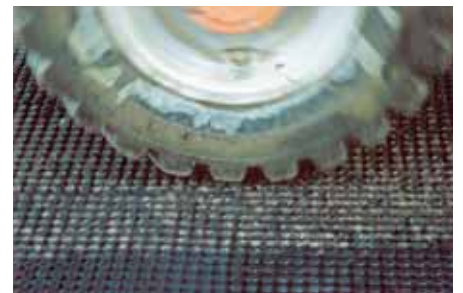

The special Filter Sheet TG is used and carefully installed with an overlap of at least 200 mm. The bedding can then be applied in the appropriate height according to additional technical contract terms of the German Road and Transportation Research Association (FGSV) or relevant local regulations.



It must also be ensured that the pavement is suitable for bearing the high traffic loads and that it is in accordance with the standards and regulations.

The joints of the pavement must be carried out according to German Standard DIN 18318 or any applying regulations. It is recommended that the jointing material is carefully flushed in to ensure the necessary support and stability. This surface layer will last the "lifetime" of the building as long as the condition of the joints is maintained regularly.







from 150 mm

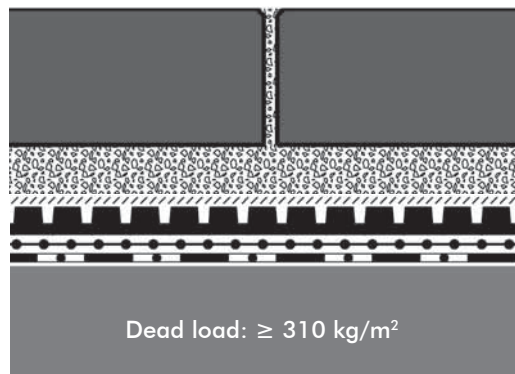

Pavers

Bedding layer 30–50 mm

Filter Sheet TG

Elastodrain® EL 202

2 layers of Slip Sheet TGF 20

Stable roof construction with suitbale waterproofing



# Driveways for Lorries with Elastodrain® EL 202 and Base Layer

Occasionally, roofs and their surfaces have to bear exceptionally heavy loads in case of delivery or fire brigade access for example.

The size of pavers or concrete slabs has to be chosen to enable a horizontal absorption of forces and an economic installation pattern at the same time. For wheel loads from 3 tons up to 10 tons, a

load-distributing base layer must be installed. Especially heavy loads require especially good protection layers in order to safeguard the waterproofing. An additional Slip Sheet (2-layers) is also used to absorb torsional moments and forces from steering, braking and acceleration to protect the waterproofing. The edging surrounding the traffic

surface is enormously important and must be stable enough to support traffic related forces. Protection of the waterproofing at the edge areas must also be taken into consideration.



Elastodrain® allows heavy machinery to access the site even during the installation of the System Build-up.



The base layer must be compacted before the pavers or asphalt are placed. The most suitable plate vibrator depends on the thickness of the base layer and the vibration susceptibility of the building.



For large areas a mechanical installation of the pavement or asphalt layer is possible.

## Safe drainage

For "sealed" paving surfaces water drainage is required on two levels.

With the ZinCo Heavy Duty Inspection Chamber BES these drainage requirements are satisfied. It can be adjusted to nearly any height and is durable enough to be driven over by lorries.

The pre-assembled Filter Sheet flange of the inspection chamber prevents the bedding material and small particles of the base layer from being washed out and, therefore prevents settlement.

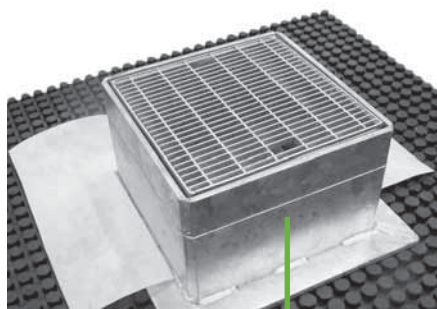

*The Heavy Duty Inspection Chamber BES is equipped with a load distributing steel flange. Installed on top of EL 202, this inspection chamber is extremely stable.*

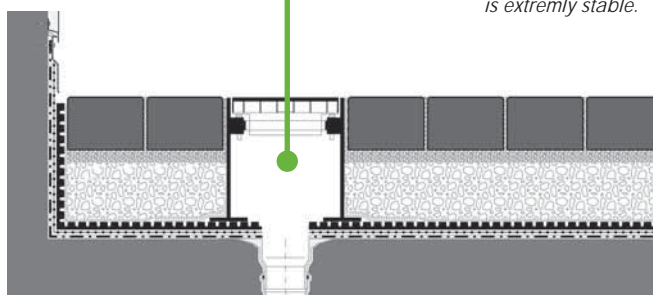





from 320 mm

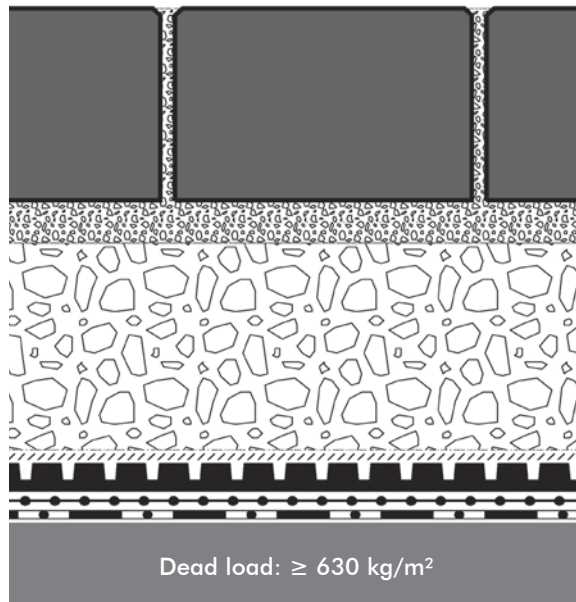

Pavement  
 $\geq 120$  mm up to 16 t  
 $\geq 140$  mm up to 60 t



Bedding layer 30–50 mm

Gravel base layer  $\geq 150$  mm

Filter Sheet PV  
 Elastodrain® EL 202  
 2 layers of Slip Sheet TGF 20

Stable roof construction with  
 suitable waterproofing

**Various drainage possibilities at a glance:**

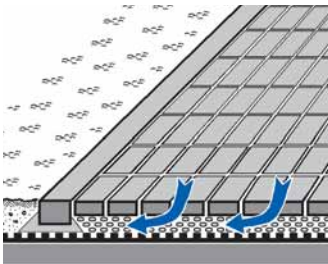

Drainage through joints of paving into the drainage layer.

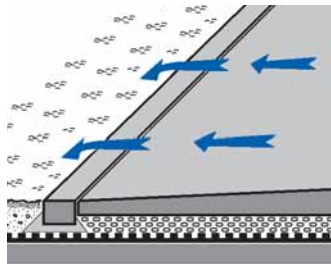

Drainage over edging into the green area.

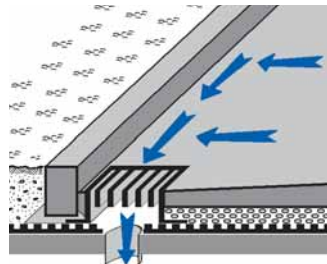

Drainage with solid driveable inspection chamber within the driving surface.

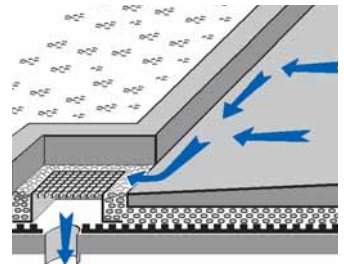

Drainage with walkable grill next to the driving surface.



# The Combination of Driveways and Vegetated Areas on Underground Garages with Protectodrain® PD 250



Due to easy accessibility and usually high load bearing capacity of underground garage decks it is often desired to work economically and apply the substrate with a wheel loader.

For this application the System Build-up "Underground Garage" with Protectodrain® PD 250 is perfectly suited as the protection and drainage mat Protectodrain® PD 250 protects the waterproofing against all kinds of mechanical stress already during construction. Covered with the very stable Filter Sheet PV it provides safe drainage for excess water.

Together with Zincolit® Plus and the System Substrates the System Build-up offers a lot of possibilities of landscape design.







Protectodrain® PD 250 is a solid, heavy-duty drainage board made of molded ABS plastic with a bottom side laminated-rubber protection mat and surrounding lateral step joints.

For a better fixing of the PD 250-boards special connectors are available. They can be plugged onto the "mushroom-shaped" studs a long the edges of the abutting boards. We recommend one connector per meter.

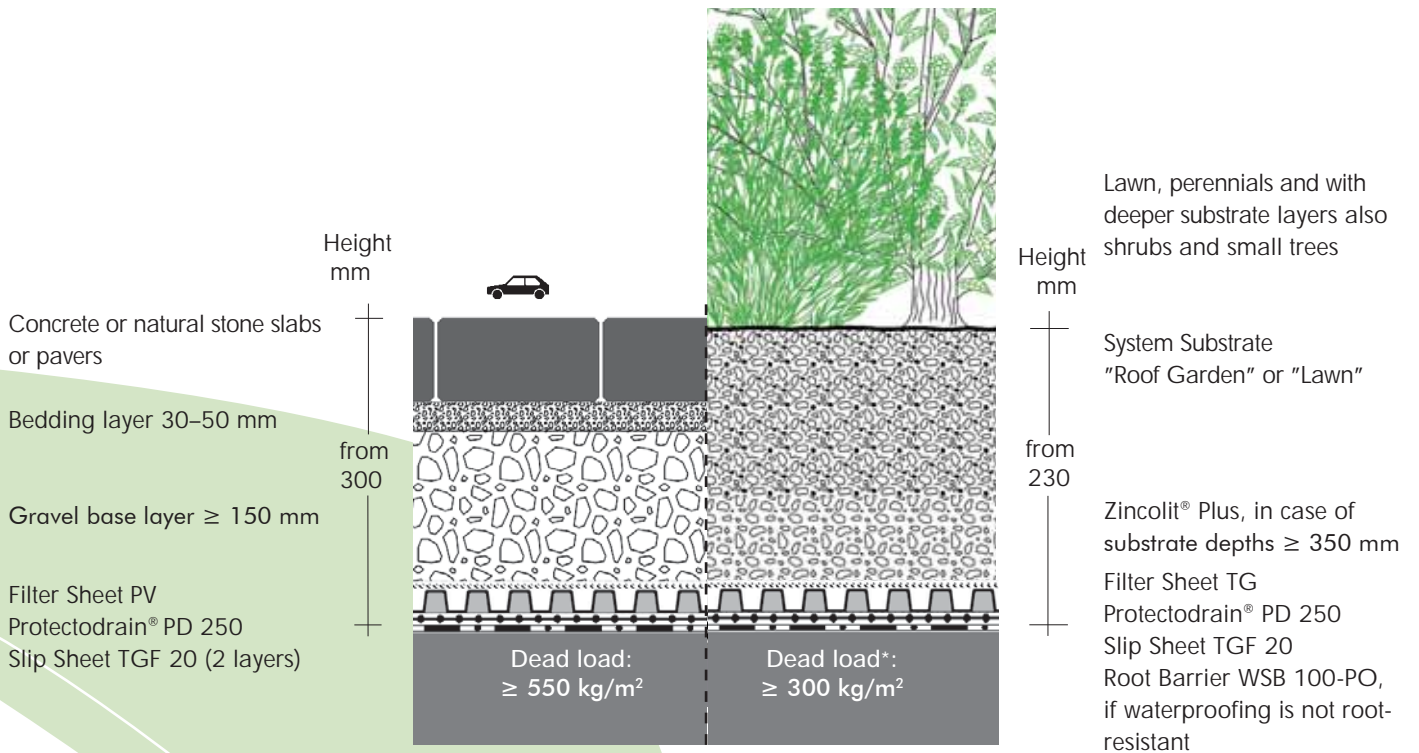

# Green Car Parks and Fire Lanes, Gravel Grass, Grass Pavers, Grid Elements ...

When surfaces are sealed they create especially high water run-off. Surfaces with a high level of use can not always be constructed water permeably. However, for drivable surfaces which are less frequented a green driveway can provide a solution. There is a wide range of

solutions (see pictures below). The green portions range from little sections growing between pavings to full surface coverings of pre-cultivated grid elements. Even a lean system build-up without reinforcement is possible – see gravel grass below. This can be a favourable

alternative as an ecological compensation layer with low visual demands. However, it is not recommended for frequently used areas.



Gravel grass



Pavement joint greening



Grass pavers

## System Build-up with Grid Elements

Stabilizing Grid Elements can provide an attractive driveable surface when cultivated with grass. Depending on the use it needs to be mown 15–20 times per year. The water supply, in the absence of natural precipitation, needs to meet the local climatic conditions. It is recommended to install an automatic irrigation system.

The result is a visually appealing lawn. It is recommended to apply such Grid Elements only on less frequented parking areas. Any surfaces close to entrances should still be made of asphalt or concrete slabs. The use of pre-cultivated Grid Elements is also possible on natural soil.

## The load bearing capacity of Grid Elements:

Car < 3 t max.\*  
5 crossings per day resp. max parking duration 8–10h

Lorries < 7.5 t max:  
2 crossings per day resp. max parking duration 8–10h

Lorries < 7.5 t:  
fire access and emergency access

\* According to the grid producer





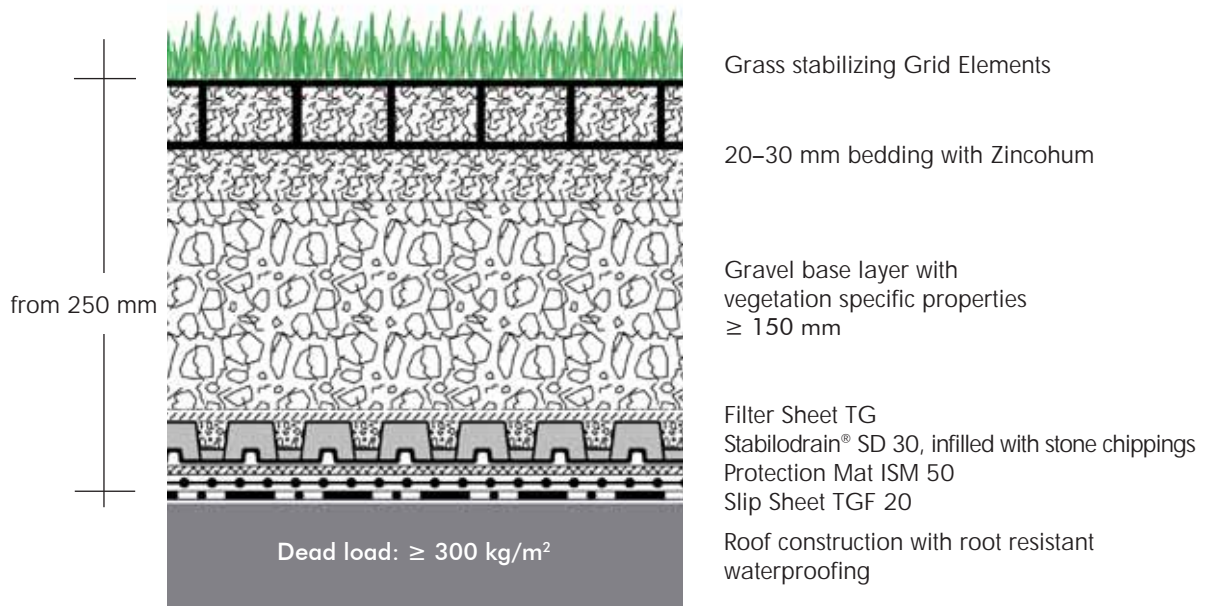

# Walk- and Driveways with Floradrain®

## FD 60 neo and Concrete / Details



### System Build-up Floradrain® FD 60 neo with load distributing concrete layer

For the application on intensive flat green roofs without pitch, a combination of Floradrain® FD 60 neo and a load distributing concrete layer are optimal for creating small sized high load bearing driveways. The wide drainage profile of Floradrain®

FD 60 neo allows for higher drainage lengths beneath the surface layer. It is necessary to fill the Floradrain® board with concrete C25/30 (or higher grade) to a minimum height of 80 mm from the top of the FD 60 neo. A reinforcement mat Q 257 A should be incorporated into the middle of the 80 mm base plate. Spacers hold the reinforcement mat in place.

To minimize cracking due the shrinkage, base plates require joints every 5 m lengthwise and crosswise. The joints need to be covered with a strip of filter sheet to avoid bedding material being washed into the joints.



*Fire brigade accessible asphalt surface.*

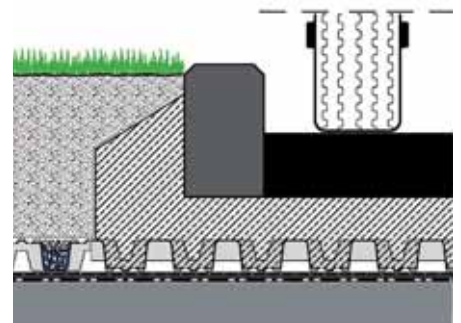

Asphalt  
Reinforced concrete  
Floradrain® FD 60 neo  
Protection Mat ISM 50  
Roof construction with root resistant waterproofing

### Waterbound macadam

It is possible to build a waterbound macadam over Elastodrain®, Stabilodrain® and Floradrain®. The material can be installed when driving on top of the already built in base layer and needs to be compacted in layers. The upper layer is installed wet and then rolled; before it dries a chipping layer is added and compacted.



*A continuous drainage layer based on Floradrain® FD 60 has been realized both below the planters and below the driveway.*



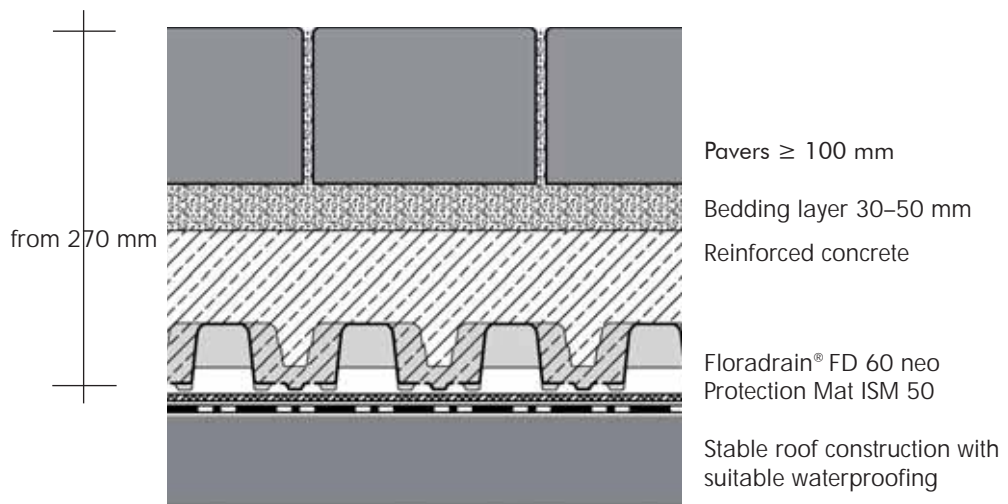

On top of gravel base layers (see previous pages) resp. on top of a concrete base layer on Floradrain® FD 60 neo the installation of asphalt or other common

landscaping materials is generally possible. Of course, a wide variety of materials can also be combined.

For special situations please contact the ZinCo Technical Department.



# Creative Solutions for Walkways and Driveways on Roofs

## Lidl Supermarkt, Huizen, Netherlands

Lidl is an international grocery discount chain operating more than 12,000 stores in Europe and the USA. This store was built in 2019 adjacent to Lidl headquarters in Huizen.

Due to the limited parking capacity around greater Amsterdam, the car park was spread over a number of storeys. The outside car park is on the concrete roof of the underground car park.

The design had to be such that it is strong enough to enable emergency response vehicles to drive over it during emergencies, in addition to the normal car traffic. Given that the area only has a slight slope and a limited build-up height, the system build-up Driveway for Lorries with Elastodrain® EL 202 was chosen. A green roof was also installed on the store itself and was combined with photovoltaic



elements. The green roof supports local biodiversity and contributes to cooling the surrounding area and to increasing the output of the photovoltaic system.



## Comturey, Mainau Island, Germany



The ZinCo system build-up Roof Garden was used with the aim of fully exploiting the potential for garden design even on the roof. The 60 mm high drainage and water storage element Floradrain® FD 60 ensures the correct balance of water. Overall, more than 16,000 plants and 200 species are grown on this 1500 m<sup>2</sup> roof.

The multi-functional system build-up al-



lows for the use of all types of covering. It can even be used for small maintenance vehicles, and for designs with decking and other seating furniture. Guardrail GB ensures safety "right at the edge". These elements are incorporated

into the green roof build-up and held in place by the weight of the build-up, and allow for the installation of the Guardrail without the need to penetrate the roof waterproof membrane.



## Kö-Bogen, Düsseldorf, Germany

The exclusive retail and office furniture store, Kö-Bogen, in the heart of Düsseldorf defines the cityscape. It's not only the six-storey building complex designed by Daniel Libeskind that is referred to as "outstanding", but also the LEED Platinum Certificate awarded for sustainable building. By the way, the name Kö-Bogen comes from the arc (Bogen) described by the street along the outer edge of Hofgarten park towards Königsallee. The overall green roof design



for the building comprises an extensive green roof with the drainage element Floraset® FS 50 and an intensive green roof for the two interior courtyard roofs with the Protection and Drainage Mat Fixodrive® FX 50. The extremely stable drainage element Stabilodrain® SD 30

was installed beneath the paving on the forecourt above the underground garage.

## SFNCC, Athens, Greece



The SNFCC Cultural Centre with the National Opera House and the National Library and a large car park is about 4.5 km from the centre of Athens. An intensive green roof is installed across the three main roofs of the complex, covering an area of approx. 25,000 m<sup>2</sup>. There is wide-ranging vegetation between the walkways and terraces of the

Mediterranean-style parkland. Native species in particular were used, for example, box trees, oregano, lavender and rosemary, and various shrubs, herbs and grasses.

The roof of the car park is planted with numerous olive trees that will thrive in a substrate layer of up to 120 cm in depth. Various drainage mats were installed,

such as the Floradrain® FD 40, Stabilodrain® SD 30 and Protectodrain® PD 250, in each case adapted to the individual context.

# Long-Lasting and Technically Sound Solutions

This Planning Guide aims to give you a general overview of the technology walkways and driveways on roofs and decks. Our technical experts will be pleased to advise you on specific solutions for your own individual building projects: from the planning phase right through to creating your specification texts.

Challenge us!



ZinCo GmbH · Lise-Meitner-Strasse 2 · 72622 Nuertingen · Germany  
Phone +49 7022 6003-0 · [info@zinco-greenroof.com](mailto:info@zinco-greenroof.com) · [www.zinco-greenroof.com](http://www.zinco-greenroof.com)